









melford **FALCON SELF-SERVICE KIOSK**

The Falcon offers a slim, robust solution that provides a secure platform whilst maintaining a small footprint. The customer experiences a fully interactive solution where a self-service kiosk solution is required ensuring clients are served quickly reducing waiting time and providing considerably more throughput efficiency and uplifts in turnover and profit.

An extensive range of high-resolution P-CAP touch screen sizes are provided along with processor speeds ranging from Intel J1900 to i5. Solutions are available in 4x3 or 16x9 aspect ratios and can be used in portrait or landscape orientation. 15", 17" and 22" screen sizes are available (other sizes also available on demand).

KEY FEATURES

-  10-point P-CAP touch
-  Range of processor options
-  Portrait or landscape orientation
-  Range of screen size options
-  Various mounting options
-  Optional 1D/2D barcode scanner
-  Optional receipt printer
-  Optional payment devices

melfordtechnologies.com



Presenting the Falcon range of modular, self-service kiosks

melford

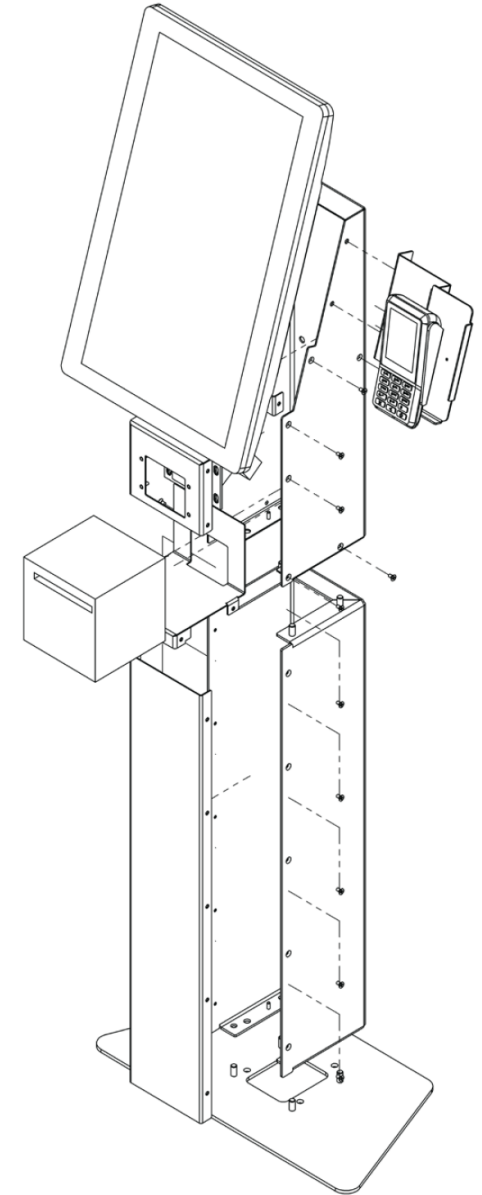
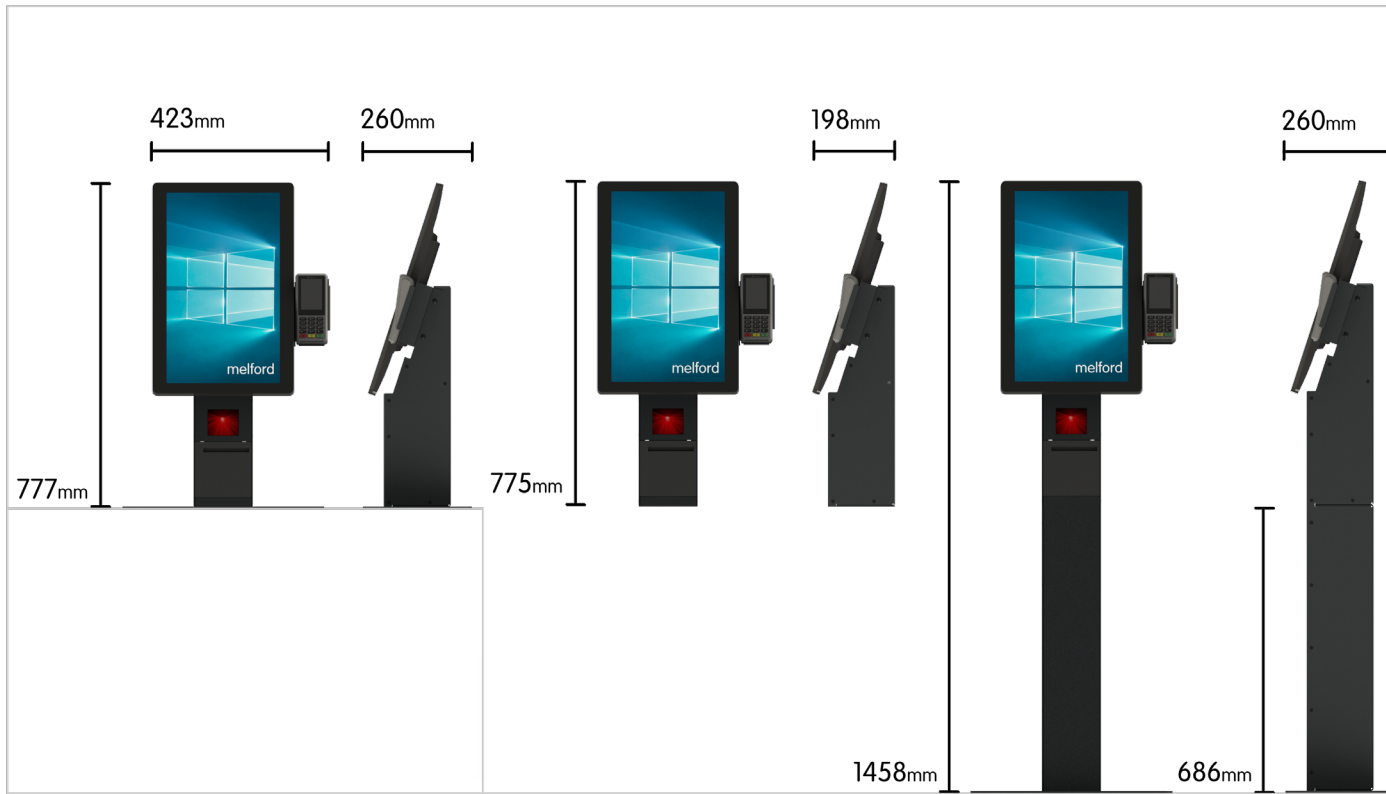

The Falcon range is available with a free-standing floor plinth, desktop mount, or wall mount. It is suitable for self-service, click and collect, customer or patient check-in, or for use in a QSR environment. The modular flexibility of the solution means it can be used in retail, hospitality, leisure, attractions, corporate and healthcare.

These self-service kiosks offer an optional 1D / 2D barcode scanner reading standard barcodes as well as vouchers and QR codes from the latest mobile devices. Receipts are generated from the integrated Epson printer (alternative printers are available on demand).

The latest chip and pin and contactless payment devices can also be utilised, including the Verifone VX820 and Ingenico Lane/3000 terminals and others on request.

melford

Falcon Self-Service Kiosk (Windows)

Processor	15" & 15.6" Intel® Celeron® J6412 1.5M Cache, 2.60GHz Intel® Core™ i3-12100TE 12M Cache, up to 4.00 GHz Intel® Core™ i5-12500TE 18M Cache, up to 4.30 GHz Intel® Celeron® G4900T 2M Cache, 2.90GHz Intel® Pentium® G5400T 4M Cache, 3.10GHz Intel Core™ i3 9100TE 6M, 3.20GHz Intel Core™ i5 9500TE 9M, 3.60GHz
	17" Intel® Celeron® G3900TE, 2.3Ghz Intel® Core i3-7101TE, 3.4Ghz Intel® Core i5-7500T, 2.7Ghz Intel® Core i7-7700T, 2.9Ghz
	22" Intel® Celeron® J6412 1.5M Cache, 2.60GHz Intel Core i3 12100TE 5M Cache, 2.1GHz Intel Core i5 12500T 7.5M Cache, 2.0GHz
Memory	Up to 16GB RAM
Display Size	15", 15.6", 17" or 22"
Panel Resolution	1920 x 1080 (Max)
Brightness	350 nits (typical)
Power	20V/90W or 20V/130W External Adapter (Power Rating 130W)
Touch Screen	10-point P-CAP touch
2D Scanner (optional)	Zebra MS4717 Cone, Honeywell V6600, N3680
Thermal Receipt Printer (optional)	Epson TM-M30ii (USB, Ethernet, NES), Star MCPrint3, FEC TPI00, Oxhoo TP85
Optional Peripherals	Holder for Verifone P400m, Ingenico Lane/3000, Verifone VX820, SumUp Air, Dojo A80, Pax S300. Holder for NFC/MIFARE Reader.
Dimensions (HxWxD)	Floor Standing: 1458mm x 423mm x 260mm Wall Mounted: 775mm x 423mm x 198mm Desk Mounted: 777mm x 423mm x 260mm
Weight (kg)	Floor Standing: 27.3kg Wall Mounted: 14.8kg Desk Mounted: 18.4kg
Accessories	3 Pin Plug, Network Cable

Why Melford?

Melford Technologies have been offering innovative technology solutions for over 50 years.

We provide experienced professional design, project planning, configuration, deployment, and maintenance services for a full one stop shop.

We can assist with the design and manufacture of your kiosk solution from the blank piece of paper at the initial meeting through to installation and post-sales support.

Contact Us

+44 (0)1494 638 069

info@melfordtechnologies.com

melfordtechnologies.com

